



Green Passion

Illustrated Parts List

XH 55 - Model Year 2010

- Use GLOBAL GARDEN PRODUCT Genuine Spare Parts specified in the parts list for repair and/or replacement.
- The contents described in the parts list may change due to improvement.
- The drawings of the spare parts are only indicative and might not represent the part in question exactly.
- The indications "right" - "left" - "front" - "rear" refer to the position of the operator when using the machine.
- When placing orders of parts for repair and/or replacement, make sure that the illustrated parts list is the one applying to the machine's year of manufacture, as shown on the identification plate attached to the machine.

COPYRIGHT by GLOBAL GARDEN PRODUCTS

All rights reserved. No part of this material may be reproduced or transmitted, in any form or by any means, electronic or mechanical, including photocopying, recording or by any information storage and retrieval system, without permission in writing from GLOBAL GARDEN PRODUCTS.

Engine 1

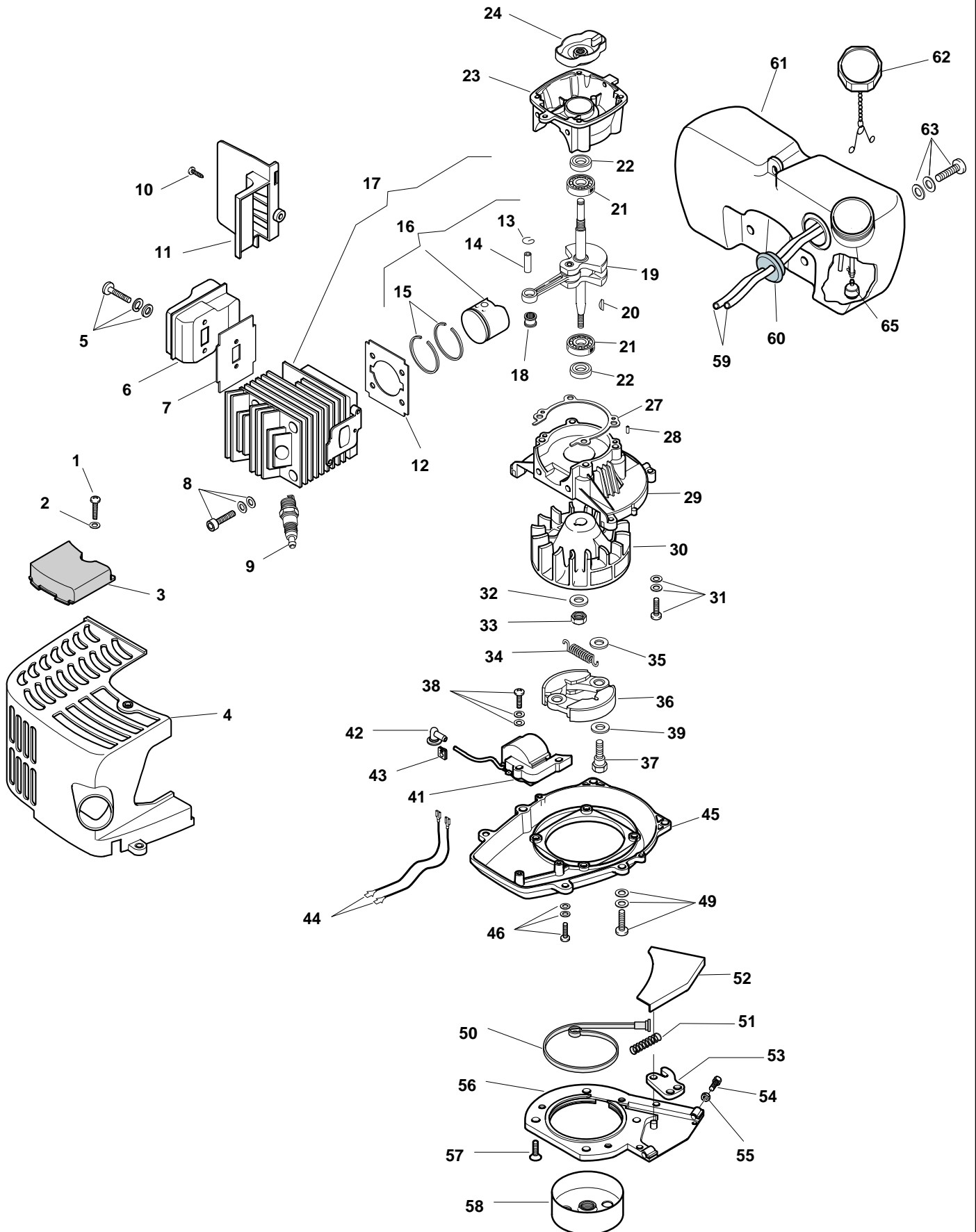



XH 55 - Model Year 2010

Engine 1

Pos.	Part no.	Q.ty	Description	Remarks
1	6981116	1	Screws Set	
2	6981154	1	Washer	
3	6981158	1	Deflector	
4	6981159	1	Engine Cover Orange	
5	6981115	2	Screws Set	
6	6981160	1	Muffler	
7	6981041	1	Gasket	
8	6981113	4	Screws Set	
9	6981163	1	Spark Plug	
10	6981116	1	Screws Set	
11	6981043	1	Guard Assy	
12	6981004	1	Cylinder Gasket	
13	6981015	2	Washer, Piston Pin	
14	6981014	1	Piston Pin	
15	6981013	2	Piston Ring	
16	6981012	1	Piston Ass' Y	
17	6981003	1	Cylinder - Piston Ass'Y	
18	6981017	1	Needle Bearing	
19	6981016	1	Crankshaft	
20	6981096	1	Flywheel Key	
21	6981110	2	Bearing	
22	6981008	2	Seal Ring	
23	6981006	1	Rear Crank Case	
24	6981031/1	1	Starter Cup	
27	6981007	1	Gasket	
28	6981126	2	Centring Pin	
29	6981005	1	Front Crank Case	
30	118800390/0	1	Flywheel Ass.Y	
31	6981102	4	Screws Set	
32	6981128	1	Washer	
33	6981143	1	Nut	
34	6981034	1	Spring	
35	6981276	2	Washer	
36	6981032	2	Clutch Unit	
37	6981035	2	Screw	
38	6981116	2	Screws Set	
39	6981033	2	Washer	
41	118800391/0	1	Elettronic Coil	
42	6981023	1	Cover, Spark Plug	
43	6981133	1	Cable Retainer	
44	6981022	2	Cable	
45	6981205	1	Support	
46	6981116	2	Screws Set	
49	6981118	4	Screws Set	
50	6981203	1	Brake Band	
51	6981202	1	Spring	
52	6981198	1	Cover	
53	6981201	1	Lever	
54	6981200	1	Screw	
55	6981199	1	Nut	
56	6981197	1	Flange	
57	6981144	4	Screw	
58	6981164	1	Clutch Drum	
59	6981038	2	Fuel Hose	
60	6981039	1	Grommet Assy	
61	6981313	1	Kit Fuel Tank	
62	6981091	1	Cap Ass'Y, Fuel Tank	
63	6981101	3	Screws Set	
65	4253292	1	Intake Filter	

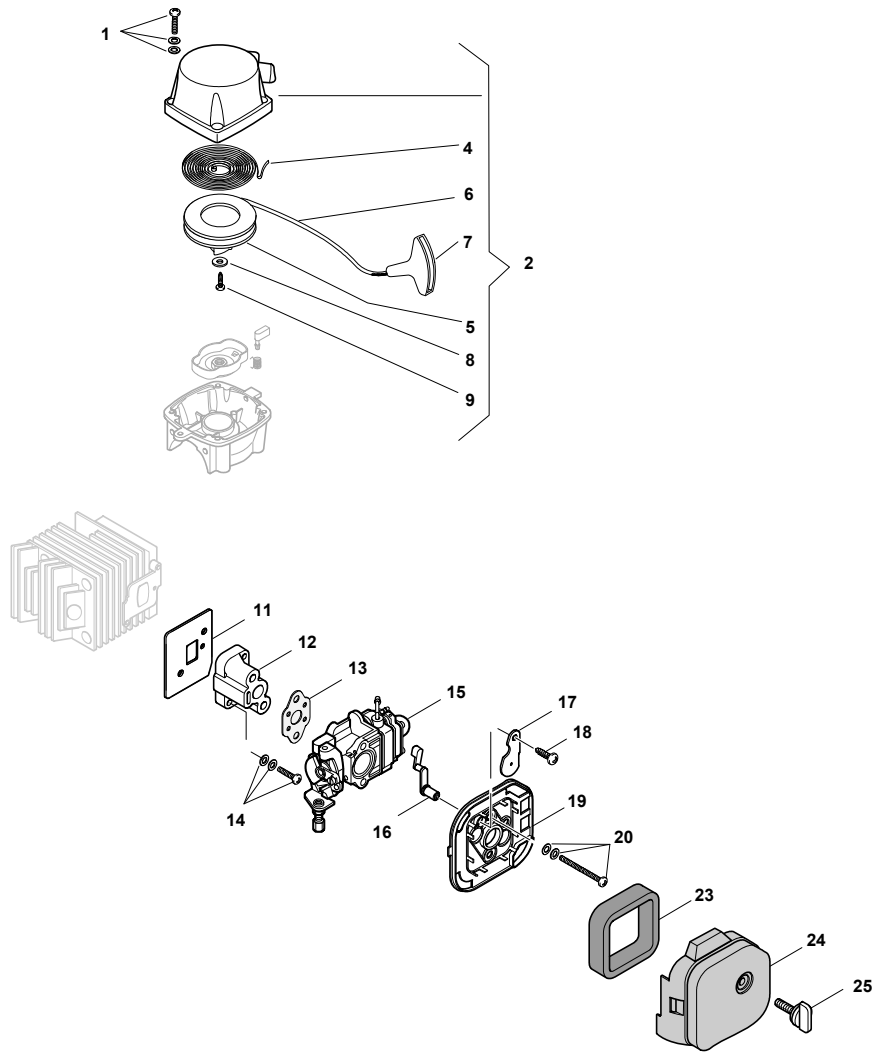
Engine 2

Pos.	Part no.	Q.ty	Description	Remarks
1	6981116	4	Screws Set	
2	6981161/1	1	Starter Ass.Y	
4	6981025	1	Spring	
5	6981026	1	Starter Pulley	
6	6981029	1	Starter Cord	
7	6981027	1	Starter Handle	
8	6981138	1	Washer	
9	6981145	1	Screw	
11	6981011	1	Intake Manif-Gasket	
12	6981010	1	Intake Manifold	
13	6981018	1	Gasket-Diaph.Set	
14	6981266	2	Screws Set	
15	118800392/0	1	Carburettor	
16	6981137	1	Choke Lever	
17	6981136	1	Starter Valve	
18	6981268	1	Screw	
19	6981131	1	Air Filter Holder	
20	6981104	2	Screws Set	
23	6981020	1	Air Filter	
24	6981134	1	Filter Cover	
25	6981132	1	Screw	

Cutting unit

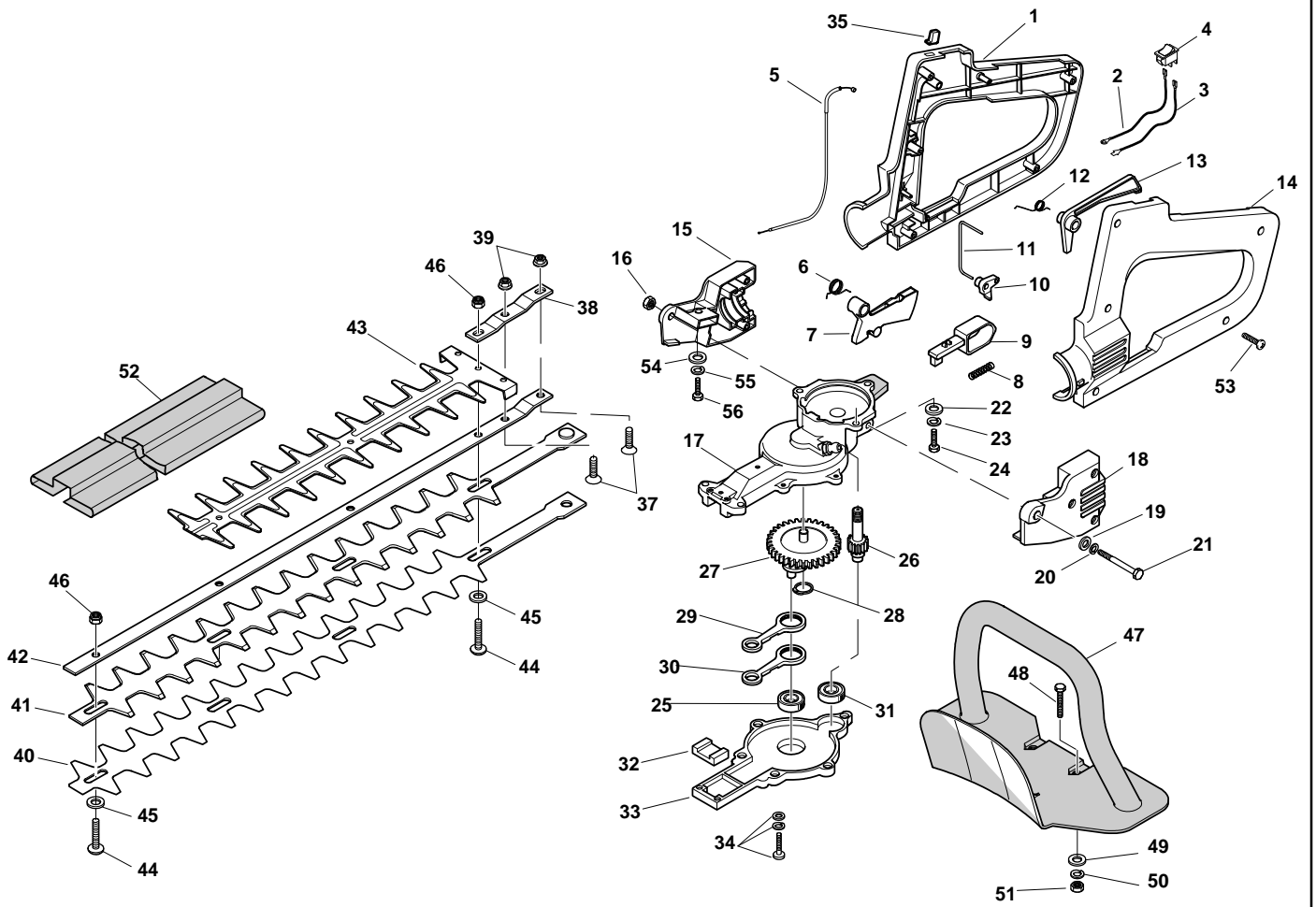



XH 55 - Model Year 2010

Cutting unit

Pos.	Part no.	Q.ty	Description	Remarks
1	6981193	1	Right Handgrip	
2	6981192	1	Earth Cable	
3	6981191	1	Coil-Switch Cable	
4	6981194	1	Stop Switch	
5	6981188	1	Cable, Trottle	
6	6981186	1	Spring	
7	6981187	1	Throttle Lever	
8	6981182	1	Spring	
9	6981183	1	Gearshift	
10	6981185	1	Hook	
11	6981184	1	Throttle Rod	
12	6981189	1	Spring	
13	6981190	1	Safety Lever	
14	6981195	1	Left Handgrip	
15	6981180	1	Right Support	
16	6981142	1	Nut	
17	6981165	1	Case	
18	6981181	1	Left Support	
19	6981155	1	Washer	
20	6981152	1	Washer	
21	6981148	1	Screw	
22	6981156	3	Washer	
23	6981153	3	Washer	
24	6981140	3	Screw	
25	6981139	1	Bearing	
26	6981175	1	Pinion	
27	6981176	1	Sprocket	
28	6981151	1	Ring	
29	6981177	1	Connecting Rod	
30	6981177	1	Connecting Rod	
31	6981110	1	Bearing	
32	6981169	1	Shoe	
33	6981179	1	Case	
34	6981100	6	Washer	
35	6981287	1	Button	
37	6981281	2	Screw	
38	6981166	1	Plate	
39	6981280	2	Nut	
40	6981171	1	Bottom Blade	
41	6981170	1	Top Blade	
42	6981168	1	Blade Holder	
43	6981167	1	Blade Guard	
44	6981173	4	Screw	
45	6981172	4	Washer	
46	6981279	4	Nut	
47	6981196	1	Fore Handle	
48	6981150	2	Screw	
49	6981155	2	Washer	
50	6981152	2	Washer	
51	6981142	2	Nut	
52	6981174	1	Blade Cover	
53	6981149	5	Screw	
54	6981155	1	Washer	
55	6981152	1	Washer	
56	6981147	1	Screw	