

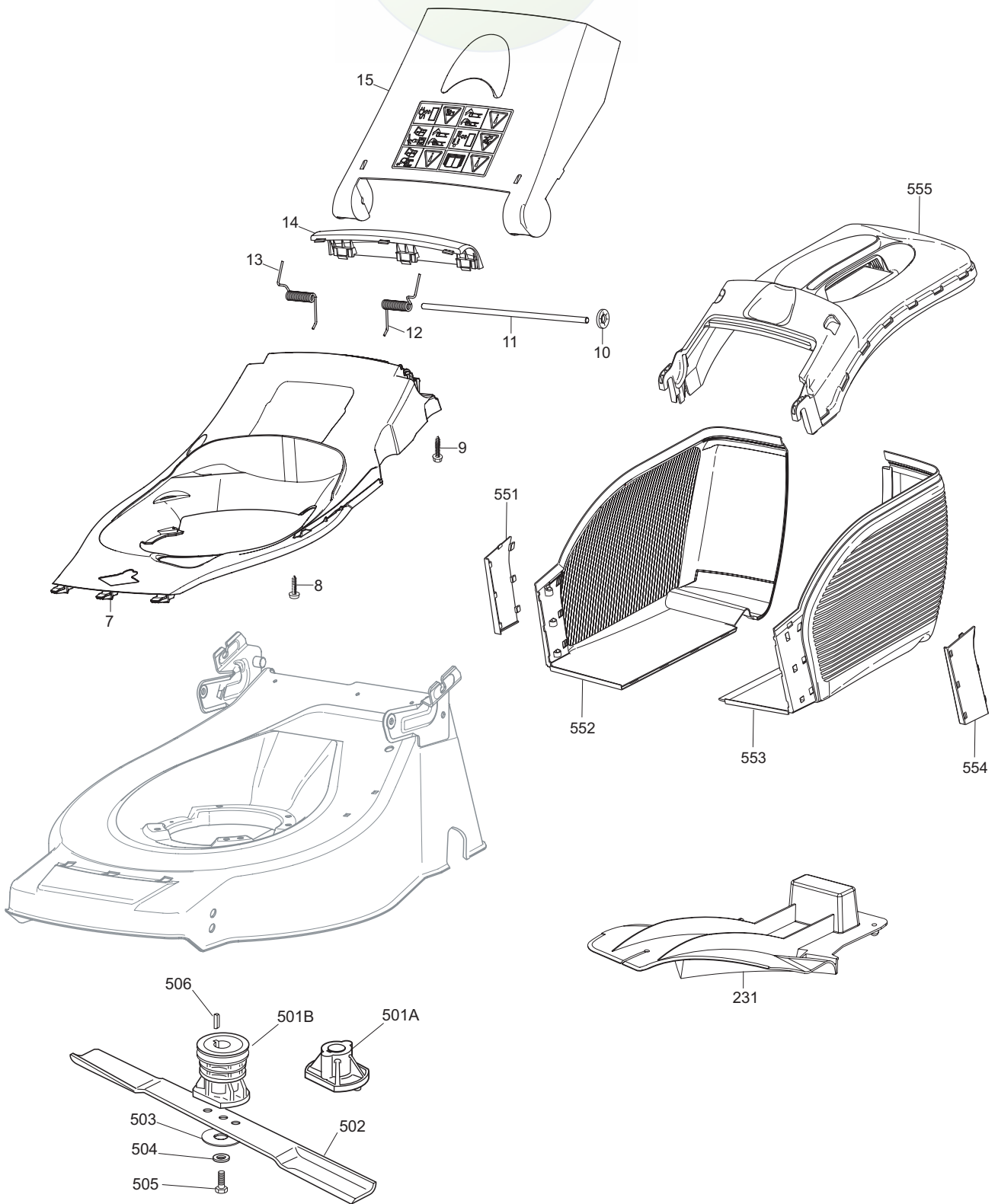

Ausgabe Issue 2006- 1		Bild Nr Picture No B109		VARIOLUX 53 BC H- 53 BCA H CHASSIE HOLM	VARIOLUX 53 BC H- 53 BCA H CHASSIS HANDLE	Seite Page 46		
Pos. Fig.	Anzahl/Quantity			Artikel Nr. Part No	Bezeichnung	Description	Satz Kit	Anmerkung Notes
	53 BCH	53 BCAH						
	1	1		1136-1754-01	Gehäuse.....	Deck.....		
	2	3	3	1136-0615-01	Schraube .....	Screw.....		
	3	1	1	1136-0645-01	Schutz .....	Protection .....		
	4	1	4	9847-8119-16	Schraube .....	Screw.....		
	5		2	1136-0682-01	Platte .....	Plate.....		
	6	1	1	1136-0665-01	Gummieinsatz.....	Rubber insert .....		
	16	2	2	1136-0061-01	Propfen.....	Cap.....		
	17	1	1	1136-1761-01	Holm- Unterteil .....	Handle- lower .....		
	18	1	1	1136-1765-01	Holmrohr .....	Handle tube .....		
	19	1	1	1136-1763-01	Holm- Oberteil .....	Handle- upper.....		
	20	1	1	1136-1716-01	Handgriff .....	Handgrip .....		
	21	2	2	1136-1733-01	Bolzen.....	Pin.....		
	22	2	2	9675-0012-02	Verriegelungsscheibe .....	Locking washer .....		
	23	4	4	1136-1755-01	Hebel .....	Handle lever .....		
	24	4	4	1136-1738-01	Scheibe.....	Washer.....		
	25	4	4	1136-0309-01	Scheibe.....	Washer.....		
	26	4	4	1136-1721-01	Schloßrad .....	Locking knob .....		
	27	4	4	9799-0831-02	Mutter .....	Nut.....		
	28	2	2	1136-1746-01	Gummistopfen.....	Cap.....		
	29	2	2	1136-1709-01	Ringmutter .....	Ring nut .....		
	30	2	2	1136-1708-01	Griff .....	Knob .....		
X	31	2	2	1136-1982-01	Schraube .....	Screw.....		
	32	1	1	1136-1720-01	Griff- untere .....	Knob- lower.....		
	33	1	1	1136-1719-01	Griff- obere .....	Knob- upper .....		
	34	1	1	1136-1762-01	Holmrohr .....	Handle tube .....		
	35	2	2	9997-0835-16	Schraube .....	Screw.....	L = 35 mm	
	36	2	2	9739-0831-22	Mutter .....	Nut.....		
	37	1	1	9997-0835-16	Schraube .....	Screw.....	L = 35 mm	
	38	1	1	9699-0090-02	Scheibe.....	Flat washer.....		
	39	1	1	9747-0831-02	Mutter.....	Lock nut.....		
	40	1	1	1136-1722-01	Seilführer .....	Guide spring .....		
	41	1	1	1136-1751-01	Motorbremsdraht .....	Engine brake cable .....		
	42	1	1	1136-1343-01	Seilöse.....	Rope guide.....		
	43	1	1	9747-0531-02	Mutter .....	Nut.....		
	44	1	1	1136-0765-01	Gasdraht.....	Throttle cable .....		
	45	1	1	9699-0028-02	Scheibe.....	Flat washer.....		
	46	1	1	1136-1680-01	Schraube .....	Screw.....		
	47	1	1	1136-1747-01	Deckel.....	Cap.....		
X	51	6	6	1136-1982-01	Schraube .....	Screw.....		
	52	1	1	1136-1710-01	Schutz .....	Protection .....		
	53	1	1	1136-1743-01	Stütz .....	Support.....		
	54	1	2	1136-1744-01	Stütz .....	Support.....		
	55	2	4	9836-9116-12	Schraube .....	Screw.....		
	56	1	1	1136-1717-01	Regulierbügel .....	Control lever .....		
	57	1	1	1136-1712-01	Schutz .....	Protection .....		
	58	2	2	1136-1692-01	Deckel.....	Cap.....		
	59	1	1	1136-1734-01	Deckel.....	Cover plate .....		
	60		1	1136-1718-01	Regulierbügel .....	Control lever .....		
	62	1	1	1136-1766-01	Gashebel.....	Throttle lever.....		
	63	1	1	1136-1742-01	Stütz .....	Support.....		
	64	1	1	9997-0625-16	Schraube .....	Screw.....		
	65	1	1	1136-0608-01	Scheibe.....	Washer.....		
	66	2	2	9699-0060-02	Scheibe.....	Flat washer.....		
	67	1	1	9747-0631-02	Mutter .....	Lock nut.....		
	103	1	1	1136-1713-01	Schutz .....	Protection .....		
	104	1	1	1136-1711-01	Schutz .....	Protection .....		
	105	2	2	1136-1692-01	Deckel.....	Cap.....		
X	106	4	4	1136-1982-01	Schraube .....	Screw.....		
	111	1	1	1136-1768-01	Schraubensatz .....	Screw set .....		





Ausgabe Issue 2006- 1		Bild Nr Picture No B111		VARIOLUX 53 BC H- 53 BCA H MESSER GRASFANGKORB	VARIOLUX 53 BC H- 53 BCA H BLADE GRASS BOX	Seite Page 48		
Pos. Fig.	Anzahl/Quantity			Artikel Nr. Part No	Bezeichnung	Description	Satz Kit	Anmerkung Notes
	53 BCH	53 BCAH						
7	1	1		1136-1696-01	Haube .....	Cover .....		
8	2	2		1117-3226-01	Schraube .....	Screw .....		
9	3	3		1136-1458-01	Schraube .....	Screw .....		
10	2	2		9675-0012-02	Verriegelungsscheibe .....	Locking washer .....		
11	1	1		1136-1731-01	Stange .....	Rod .....		
12	1	1		1136-1723-01	Feder- links .....	Spring- LH .....		
13	1	1		1136-1724-01	Feder- rechts .....	Spring- RH .....		
14	1	1		1136-1698-01	Halter .....	Support .....		
15	1	1		1136-1736-01	Klappe .....	Rear flap .....		
231	1	1		1136-0656-01	Deflektor .....	Deflector .....		
501 A	1			1111-9743-01	Nabe .....	Hub .....		
501 B		1		1111-9744-01	Nabe m. Scheibe .....	Hub w. pulley .....		
502	1	1		1111-9726-01	Messer .....	Blade .....		
503	1	1		1136-0083-01	Federscheibe .....	Elastic washer .....		
504	1	1		1136-0015-01	Scheibe .....	Washer .....		
505	1	1		9987-5251-12	Schraube .....	Screw .....		
506	1	1		9600-0014-00	Keil .....	Key .....		
551	1	1		1136-1729-01	Profil- rechts .....	Profile- RH .....		
552	1	1		1136-1727-01	Graskorb- rechts .....	Grassbox lower- RH .....		
553	1	1		1136-1728-01	Graskorb- links .....	Grassbox lower- LH .....		
554	1	1		1136-1730-01	Profil- links .....	Profile- LH .....		
555	1	1		1136-1726-01	Graskorb- Oberteil .....	Grassbox- upper .....		

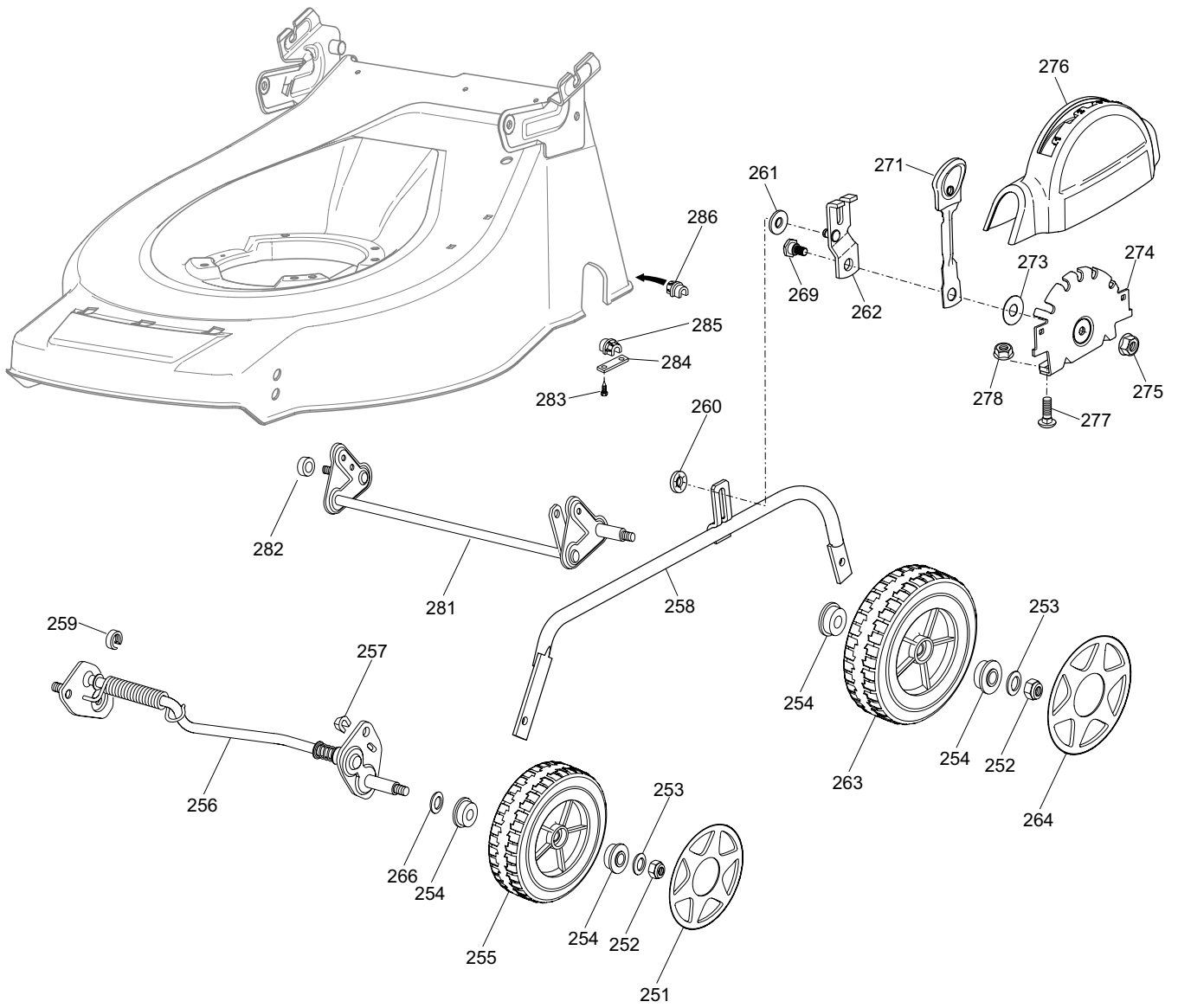

B107



Ausgabe Issue 2006- 1		Bild Nr Picture No B107		VARIOLUX 53 BC H RADAUFHÄNGUNG		VARIOLUX 53 BC H WHEEL SUSPENSION		Seite Page 50	
Pos. Fig.	Anzahl/Quantity			Artikel Nr. Part No	Bezeichnung	Description	Satz Kit	Anmerkung Notes	
251	2			1136-1701-01	Radkappe- grau .....	Hub cap- grey .....			
252	4			9747-0831-02	Mutter .....	Lock nut .....			
253	4			9699-0090-02	Scheibe .....	Flat washer .....			
254	8			1136-0655-01	Kugellager .....	Ball bearing .....			
255	2			1136-1520-01	Rad .....	Wheel .....			
256	1			1136-0712-01	Vorderradachse .....	Front wheel axle .....			
257	2			1136-0009-01	Schließplatte .....	Lock plate .....			
258	1			1136-1758-01	Höhenverstellstange .....	Height adjust rod .....			
259	1			1136-0658-01	Distanzring .....	Spacer .....			
260	1			9675-0009-02	Verriegelungsscheibe .....	Starlock .....			
261	1			1136-0006-01	Federscheibe .....	Elastic washer .....			
262	1			1136-1757-01	Halter .....	Attachment .....			
263	2			1136-0772-01	Rad .....	Wheel .....			
264	2			1136-1702-01	Radkappe- grau .....	Hub cap- grey .....			
266	4			1136-0609-01	Elastische Scheibe .....	Elastic washer .....			
269	1			1136-1732-01	Schulterschraube .....	Shoulder bolt .....			
271	1			1136-1756-01	Höhenverstellhebel .....	Height adjust lever .....			
273	1			1136-0089-01	Scheibe .....	Washer .....			
274	1			1136-1740-01	Sektor .....	Height adjust sector .....			
275	1			9739-0831-22	Mutter .....	Nut .....			
276	1			1136-1693-01	Deckel .....	Cover .....			
277	2			9898-0616-16	Schraube .....	Screw .....			
278	2			9739-0631-22	Mutter .....	Nut .....			
281	1			1136-0729-01	Hinterradachse .....	Rear wheel axle .....			
282	1			1136-0657-01	Distanzring .....	Spacer .....			
283	4			9847-8119-16	Schraube .....	Screw .....			
284	2			1136-0681-01	Platte .....	Plate .....			
285	1			1136-0636-01	Buchse- links .....	Bush- LH .....			
286	1			1136-0635-01	Buchse- rechts .....	Bush- RH .....			

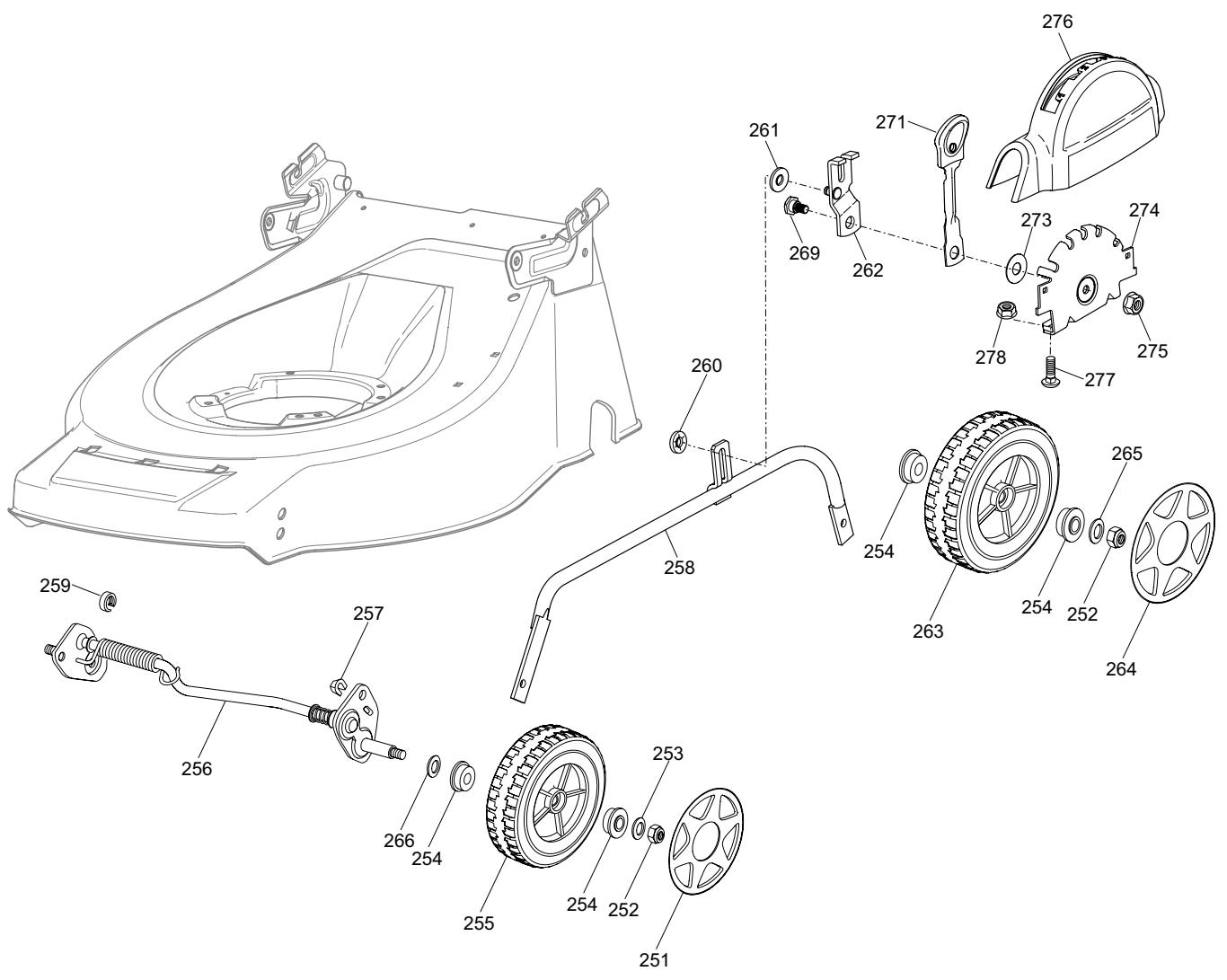
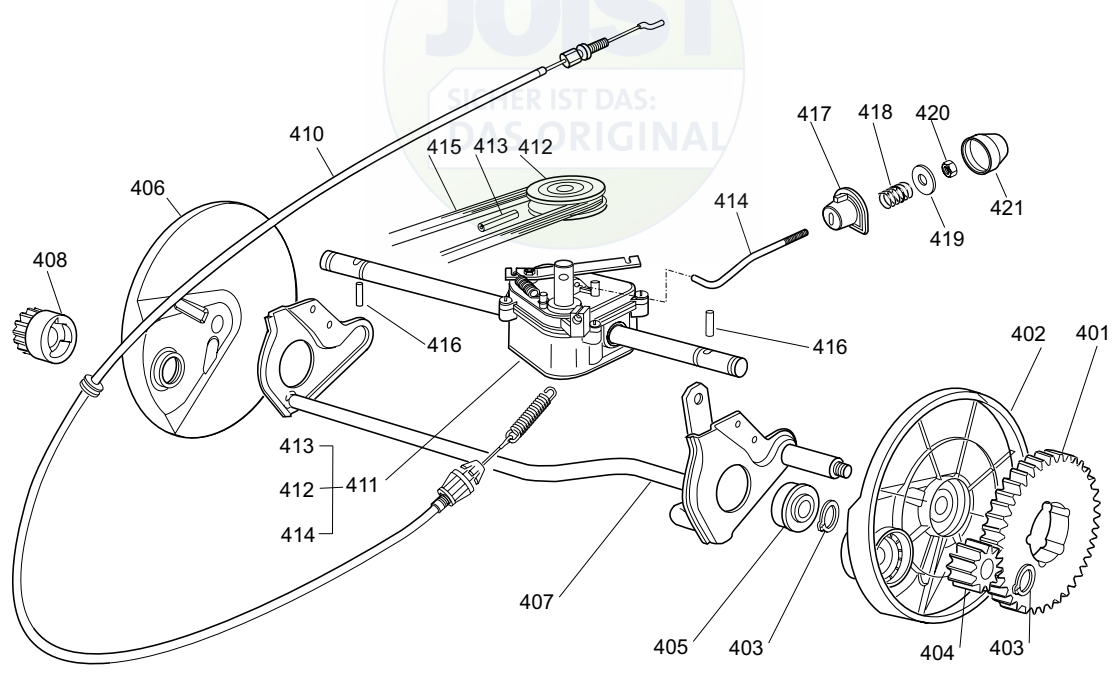
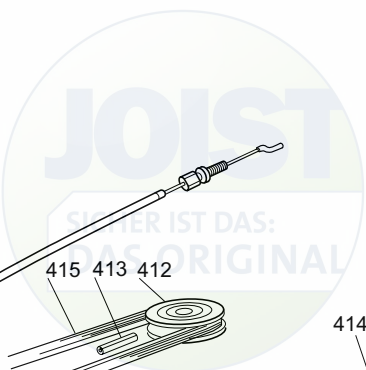

B103





Ausgabe Issue 2006- 1		Bild Nr Picture No B103		VARIOLUX 53 BCA H RADAUFHÄNGUNG GETRIEBE		VARIOLUX 53 BCA H WHEEL SUSPENSION TRANSMISSION		Seite Page 52	
Pos. Fig.	Anzahl/Quantity				Artikel Nr. Part No	Bezeichnung	Description	Satz Kit	Anmerkung Notes
251	2				1136-1701-01	Radkappe- grau .....	Hub cap- grey .....		
252	4				9747-0831-02	Mutter .....	Lock nut .....		
253	2				9699-0090-02	Scheibe .....	Flat washer .....		
254	8				1136-0655-01	Kugellager .....	Ball bearing .....		
255	2				1136-1520-01	Rad .....	Wheel .....		
256	1				1136-0712-01	Vorderradachse .....	Front wheel axle .....		
257	2				1136-0009-01	Schließplatte .....	Lock plate .....		
258	1				1136-1758-01	Höhenverstellstange .....	Height adjust rod .....		
259	1				1136-0658-01	Distanzring .....	Spacer .....		
260	1				9675-0009-02	Verriegelungsscheibe .....	Starlock .....		
261	1				1136-0006-01	Federscheibe .....	Elastic washer .....		
262	1				1136-1757-01	Halter .....	Attachment .....		
263	2				1136-0772-01	Rad .....	Wheel .....		
264	2				1136-1702-01	Radkappe- grau .....	Hub cap- grey .....		
265	2				1136-0006-01	Federscheibe .....	Elastic washer .....		
266	2				1136-0609-01	Elastische Scheibe .....	Elastic washer .....		
269	1				1136-1732-01	Schulterschraube .....	Shoulder bolt .....		
271	1				1136-1756-01	Höhenverstellhebel .....	Height adjust lever .....		
273	1				1136-0089-01	Scheibe .....	Washer .....		
274	1				1136-1740-01	Sektor .....	Height adjust sector .....		
275	1				9739-0831-22	Mutter .....	Nut .....		
276	1				1136-1693-01	Deckel .....	Cover .....		
277	2				9898-0616-16	Schraube .....	Screw .....		
278	2				9739-0631-22	Mutter .....	Nut .....		
401	2				1136-0653-01	Kranz .....	Ring gear .....		
402	1				1136-0690-01	Radschutz- links .....	Wheel protection- LH .....		
403	4				9650-0012-04	Seegersicherung .....	Circlip .....		
404	1				1136-0685-01	Ritzel- links .....	Pinion- LH .....		
405	2				1136-0632-01	Lager .....	Bearing .....		
406	1				1136-0689-01	Radschutz- rechts .....	Wheel protection- RH .....		
407	1				1136-0713-01	Hinterradachse .....	Rear wheel axle .....		
408	1				1136-0684-01	Ritzel- rechts .....	Pinion- RH .....		
410	1				1136-1748-01	Kupplungsdraht .....	Clutch cable .....		
411	1				1136-1456-01	Getriebe Kpl (schw) .....	Gearbox assy (black) .....		
412	1				1136-0692-01	Riemenscheibe .....	Pulley .....		
413	1				1136-0612-01	Stift .....	Pin .....		
414	1				1136-1454-01	Verstellstange .....	Adjustment rod .....		
415	1				1111-9746-01	Riemen .....	Belt .....		
416	2				1136-0697-01	Stift .....	Pin .....		
417	1				1136-0638-01	Buchse .....	Bush .....		
418	1				1136-0668-01	Feder .....	Spring .....		
419	1				1136-0091-01	Scheibe .....	Washer .....		
420	1				9747-0631-02	Mutter .....	Lock nut .....		
421	1				1136-0081-01	Nabenkapsel .....	Hub cap .....		