

## Section: SERVICE MATERIAL

Pos.	Quantity	Spare part No	Description	Kit	Notes	New
1	1	1111-9028-02	Spark plug			
2	1	9400-0225-00	Spark plug		Champion J19LM	
3	1	9400-0226-00	Spark plug		Champion RDJ7Y	
4	1	1111-9029-01	Spark plug wrench		19/21 mm	
5	1	1111-9029-02	Spark plug wrench		16 mm	
6	1	1111-2414-01	Control-universal t			
7	1	1111-2419-01	Control wire			
8	1	1111-2560-01	Special tool			

test

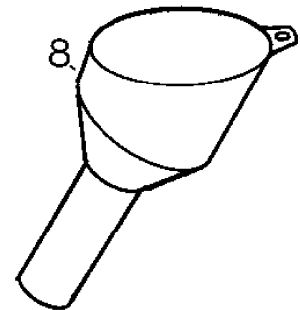
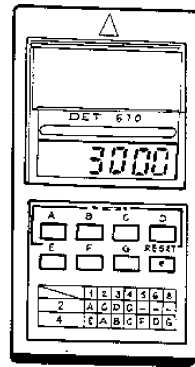
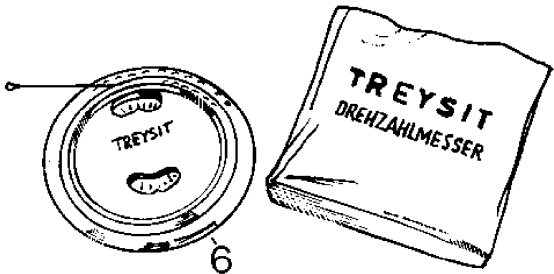
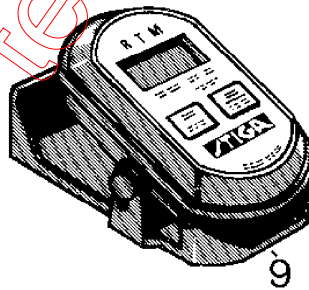
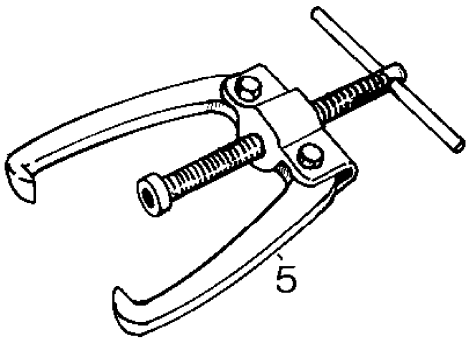
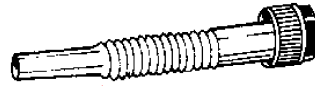
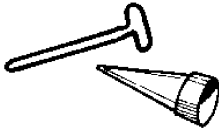
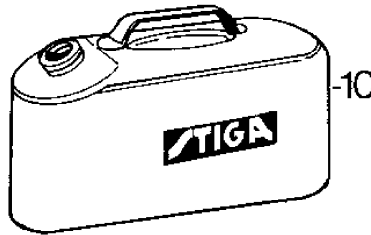
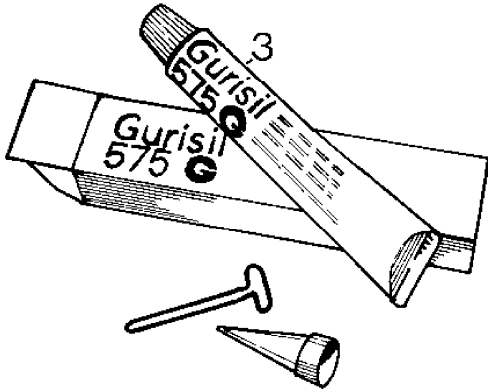
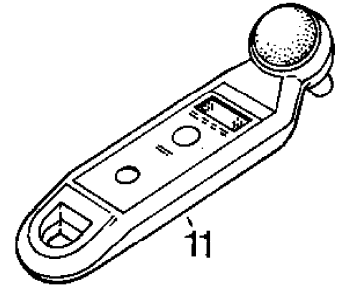
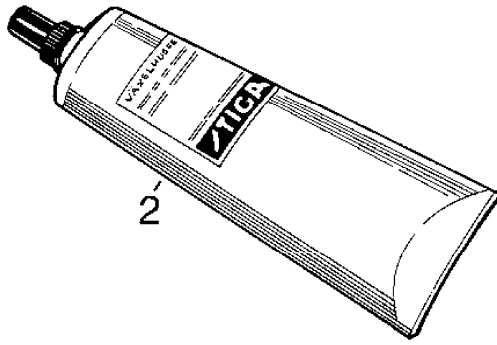
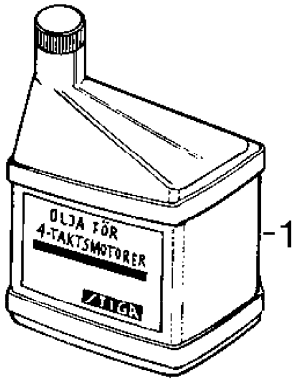

## Section: SERVICE MATERIAL

Pos.	Quantity	Spare part No	Description	Kit	Notes	New
0	1	1111-9010-03	Carton with oil		SAE 10W-30	
2	1	1111-1843-01	Special grease			
3	1	1151-0348-01	Gurisol-sealing.com		60 cc	
4	1	9498-0310-70	Spray paint-black		500 cc	
4	1	9498-0310-40	Spray paint-yellow		500 cc	
4	1	9498-0310-10	Spray paint-red		500 cc	
5	1	1151-0399-01	Puller			
6	1	1151-0429-01	Engine tachometer		Mekanisk	
7	1	9500-9919-00	Engine tachometer		Digital	
8	1	1111-1238-01	Funnel			
9	1	9500-9993-00	Running time meter			
10	1	9500-9995-00	Petrol can			
11	1	9500-9997-00	Tire pressure gauge			

test